

ACE industrial gas springs are maintenance-free and self-contained. They are available with body diameters from 8 mm up to 70 mm, and forces from 10 N up to 13 000 N ex. stock. **ACE gas springs offer a high service life with a wear-resistant coating on the piston rod. Also an integrated low friction bearing with grease chamber which provides a very low break away force (GS-19 to GS-40).** It allows them to be mounted in any orientation, although rod downwards is preferable if you want to take advantage of the built-in end position damping. The valve allows the force to be adjusted to your specific requirements. A wide variety of interchangeable end fittings makes installation easy and versatile. ACE gas springs are universally applicable wherever you have lifting and lowering. They remove the need for "muscle power" and provide controlled motion for lids, hoods, machine guards etc. The ACE selection software quickly specifies the correct gas spring for your individual application and we can deliver, usually within 24 hours.

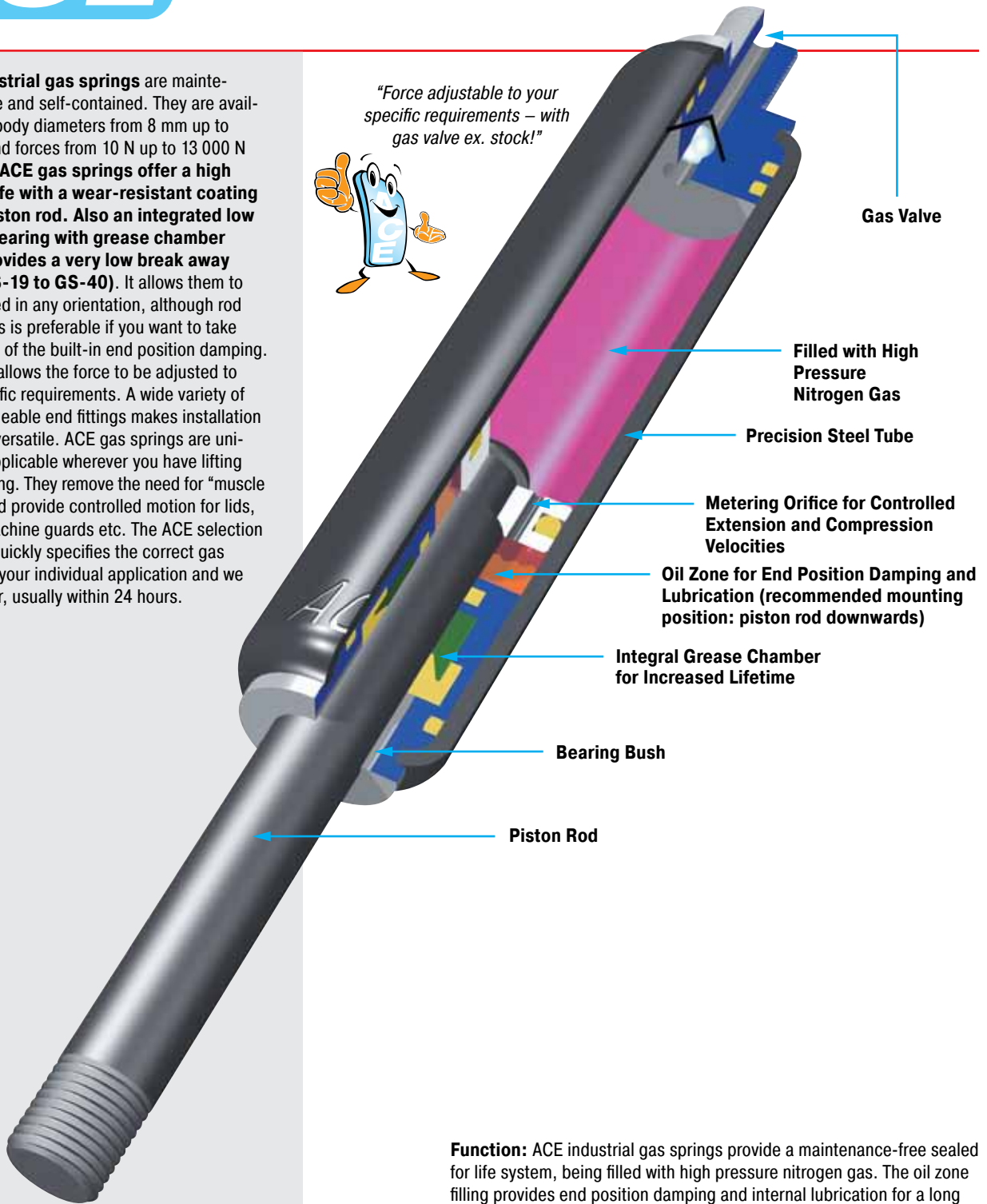

"Force adjustable to your specific requirements – with gas valve ex. stock!"



Function: ACE industrial gas springs provide a maintenance-free sealed for life system, being filled with high pressure nitrogen gas. The oil zone filling provides end position damping and internal lubrication for a long lifetime. On the extension stroke of the gas spring, for example when opening a car tailgate, the nitrogen gas flows through the metering orifice in the piston to provide a controlled opening speed and the oil zone provides damping at the fully open position to avoid impact damage. The gas spring should be mounted "rod down" for this damping to be effective. On closing the tailgate the gas spring helps support the weight. The metering orifice controls the extension and compression velocities of the gas spring.

Operating fluid: Nitrogen gas and oil

Mounting: In any position

Operating temperature range: -20 °C to 80 °C

On request: Without damping, extended length damping, special force curves, special lengths, alternative end fittings.



Extension Forces 10 N to 100 N
(when Piston Rod Compressed up to 130 N)

End Fitting

Standard Dimensions

End Fitting

A3,5

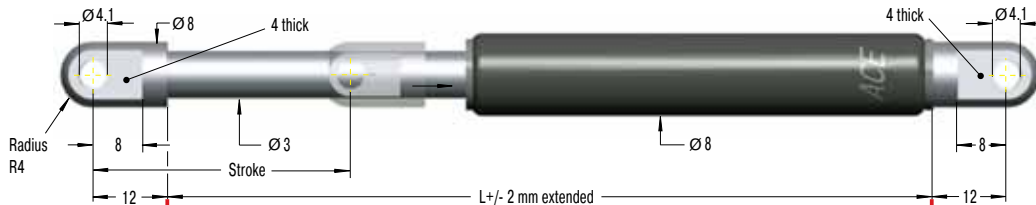

Eye A3,5
max. force 370 N

B3,5



Stud Thread B3,5

C3,5

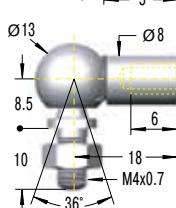

Angle Ball Joint C3,5
max. force 370 N

D3,5

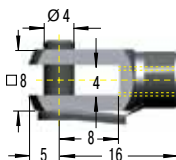

Clevis Fork D3,5
max. force 370 N

E3,5

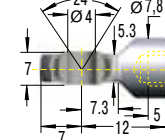

Swivel Eye E3,5
max. force 370 N

G3,5

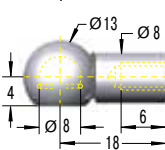

Ball Socket G3,5
max. force 370 N

Rod Shroud W3,5-8

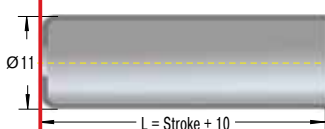

Dimensions

Type	Stroke mm	L extended
GS-8-20	20	72
GS-8-30	30	92
GS-8-40	40	112
GS-8-50	50	132
GS-8-60	60	152
GS-8-80	80	192

Ordering Example

GS-8-30-AC-30

Type (Push Type) _____
 Body Ø (8 mm) _____
 Stroke (30 mm) _____
 Piston Rod End Fitting A3,5 _____
 Body End Fitting C3,5 _____
 Nominal Force F₁ 30 N _____

The end fittings are interchangeable.
For mounting accessories see page 199.

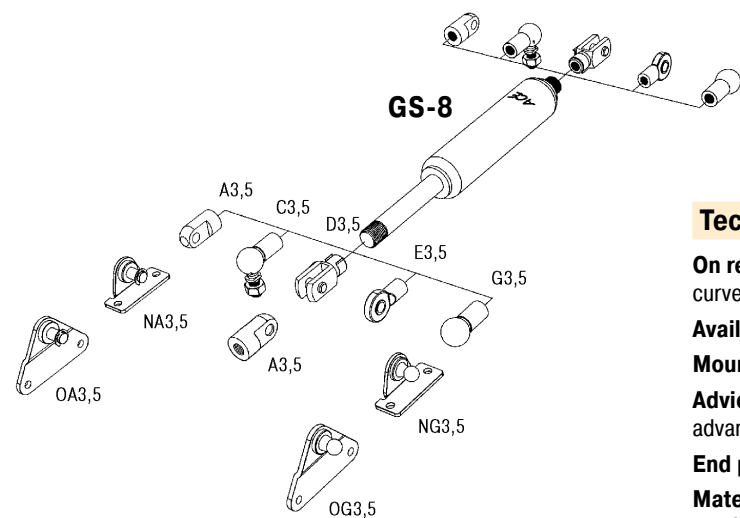

For mounting accessories see page 199.

Technical Data

On request: Without damping, extended length damping, special force curves, special lengths, alternative end fittings.

Available force range F₁ at 20 °C: 10 N to 100 N

Mounting: In any position

Advice: We recommend mounting with piston rod downwards to take advantage of the built-in end position damping.

End position damping length: Approx. 5 mm

Material: Body: Black coated steel. Piston rod: Stainless steel (1.4305). End fittings: Zinc plated steel.

Progression: Approx. 28 %, F₂ max. 130 N

Extension Forces 10 N to 100 N
(when Piston Rod Compressed up to 120 N)

End Fitting

Standard Dimensions

End Fitting

A3,5

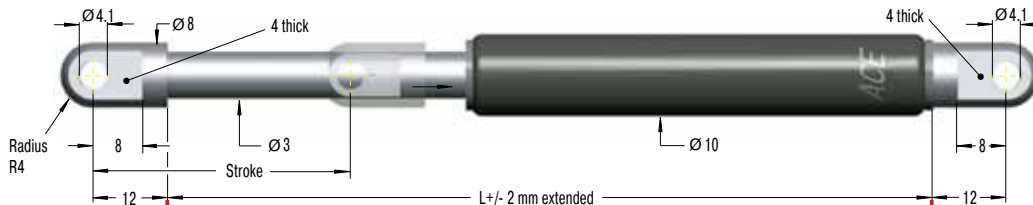

Eye A3,5
max. force 370 N

B3,5



Stud Thread B3,5

C3,5

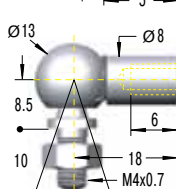

Angle Ball Joint C3,5
max. force 370 N

D3,5

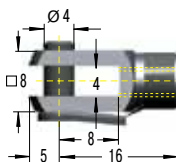

Clevis Fork D3,5
max. force 370 N

E3,5

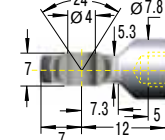

Swivel Eye E3,5
max. force 370 N

G3,5

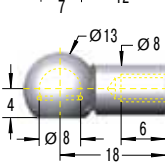

Ball Socket G3,5
max. force 370 N

Rod Shroud W3,5-10

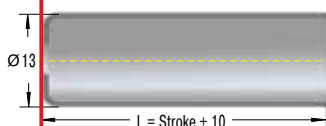

Dimensions

Type	Stroke mm	L extended
GS-10-20	20	72
GS-10-30	30	92
GS-10-40	40	112
GS-10-50	50	132
GS-10-60	60	152
GS-10-80	80	192

Ordering Example

GS-10-80-AC-60

Type (Push Type) _____
 Body Ø (10 mm) _____
 Stroke (80 mm) _____
 Piston Rod End Fitting A3,5 _____
 Body End Fitting C3,5 _____
 Nominal Force F₁ 60 N _____

The end fittings are interchangeable.
For mounting accessories see page 199.

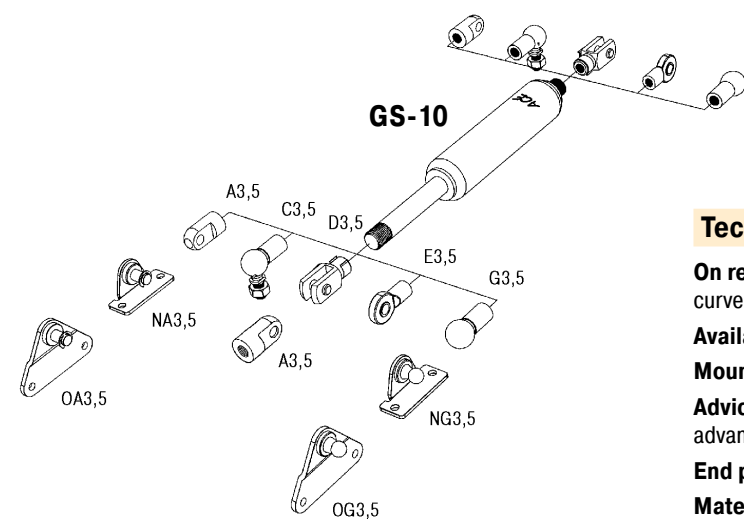

For mounting accessories see page 199.

Technical Data

On request: Without damping, extended length damping, special force curves, special lengths, alternative end fittings.

Available force range F₁ at 20 °C: 10 N to 100 N

Mounting: In any position

Advice: We recommend mounting with piston rod downwards to take advantage of the built-in end position damping.

End position damping length: Approx. 5 mm

Material: Body: Black coated steel. Piston rod: Stainless steel (1.4305). End fittings: Zinc plated steel.

Progression: Approx. 20%, F₂ max. 120 N

Extension Forces 10 N to 180 N
(when Piston Rod Compressed up to 225 N)

End Fitting

Standard Dimensions

End Fitting

A3,5 Eye **A3,5**
max. force 370 N

B3,5 Stud Thread **B3,5**

C3,5 Angle Ball Joint **C3,5**
max. force 370 N

D3,5 Clevis Fork **D3,5**
max. force 370 N

E3,5 Swivel Eye **E3,5**
max. force 370 N

G3,5 Ball Socket **G3,5**
max. force 370 N

U3,5 Adjuster Knob **U3,5**
See page 163.

Rod Shroud W3,5-12

Dimensions

Type	Stroke mm	L extended	F ₁ max. N
GS-12-20	20	72	180
GS-12-30	30	92	180
GS-12-40	40	112	180
GS-12-50	50	132	180
GS-12-60	60	152	180
GS-12-80	80	192	150
GS-12-100	100	232	150
GS-12-120	120	272	120
GS-12-150	150	332	100

Ordering Example **GS-12-100-AA-30**

Type (Push Type) _____
 Body Ø (12 mm) _____
 Stroke (100 mm) _____
 Piston Rod End Fitting A3,5 _____
 Body End Fitting A3,5 _____
 Nominal Force F₁ 30 N _____

The end fittings are interchangeable.
For mounting accessories see page 199.

Issue 6.2011 Specifications subject to change

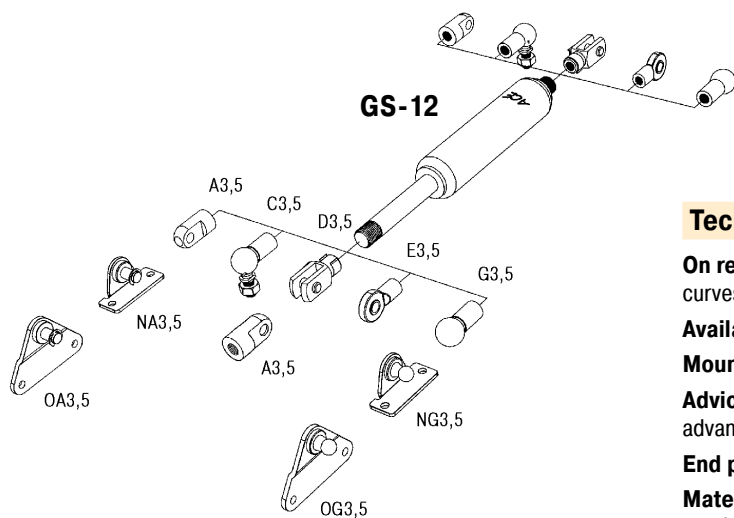

For mounting accessories see page 199.

Technical Data

On request: Without damping, extended length damping, special force curves, special lengths, alternative end fittings.

Available force range F₁ at 20 °C: 10 N to 180 N

Mounting: In any position

Advice: We recommend mounting with piston rod downwards to take advantage of the built-in end position damping.

End position damping length: Approx. 10 mm

Material: Body: Black coated steel. Piston rod: Stainless steel (1.4305). End fittings: Zinc plated steel.

Progression: Approx. 25%, F₂ max. 225 N

End Fitting

Standard Dimensions

End Fitting

A5

Eye **A5**
max. force 800 N

Dimensions

Type	Stroke mm	L extended
GS-15-20	20	67
GS-15-40	40	107
GS-15-50	50	127
GS-15-60	60	147
GS-15-80	80	187
GS-15-100	100	227
GS-15-120	120	267
GS-15-150	150	327
GS-15-200	200	427

Ordering Example

GS-15-150-AC-150

Type (Push Type) _____
 Body Ø (15.6 mm) _____
 Stroke (150 mm) _____
 Piston Rod End Fitting A5 _____
 Body End Fitting C5 _____
 Nominal Force F₁ 150 N _____

The end fittings are interchangeable.
For mounting accessories see page 199.

Adjustment
24 mm to 34 mm

See page 207 for Length Adaptor.

B5

Stud Thread **B5**

C5

Angle Ball Joint **C5**
max. force 500 N

D5

Clevis Fork **D5**
max. force 800 N

E5

Swivel Eye **E5**
max. force 800 N

F5

Inline Ball Joint **F5**
max. force 500 N

G5

Ball Socket **G5**
max. force 500 N

U5

Adjuster Knob **U5**
See page 163.

Rod Shroud W5-15

Ø 19
L = Stroke + 20

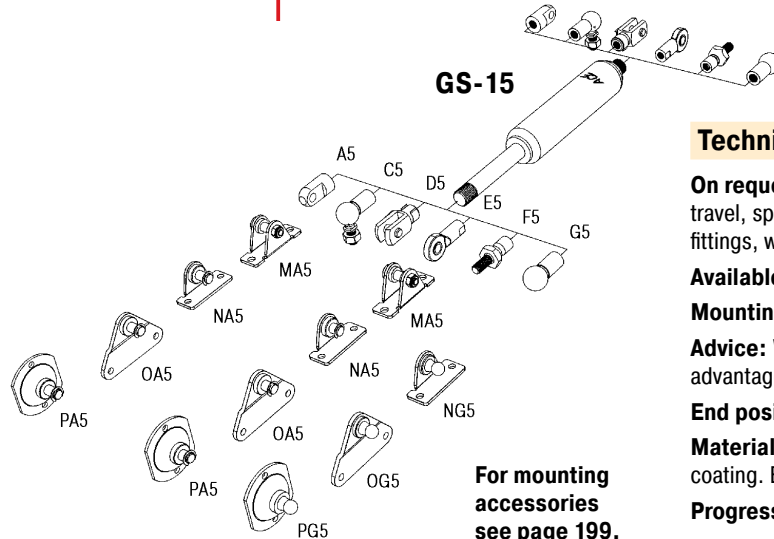

Technical Data

On request: Without damping, increased damping action at end of travel, special force curves, special lengths, strokes, alternative end fittings, wiper, stainless steel (see pages 179 to 186).

Available force range F₁ at 20 °C: 40 N to 400 N

Mounting: In any position

Advice: We recommend mounting with piston rod downwards to take advantage of the built-in end position damping.

End position damping length: Approx. 10 mm

Material: Body: Black coated steel. Piston rod: With wear-resistant coating. End fittings: Zinc plated steel.

Progression: Approx. 27%, F₂ max. 500 N

Extension Forces 50 N to 700 N
(when Piston Rod Compressed up to 995 N)

End Fitting

Standard Dimensions

End Fitting

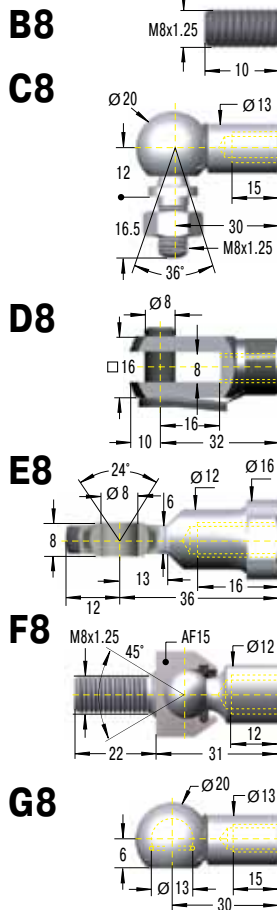
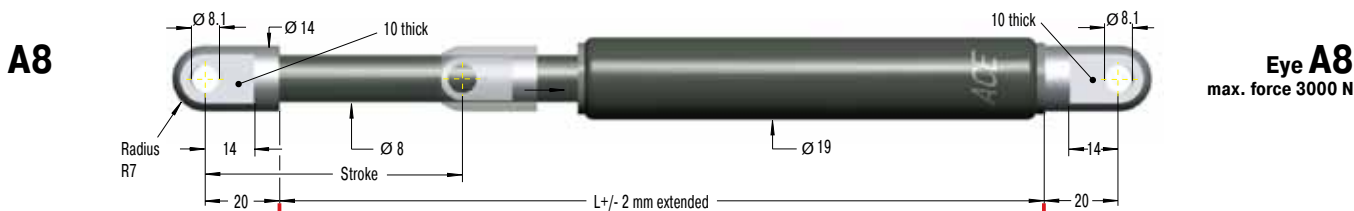

Dimensions		
Type	Stroke mm	L extended
GS-19-50	50	164
GS-19-100	100	264
GS-19-150	150	364
GS-19-200	200	464
GS-19-250	250	564
GS-19-300	300	664

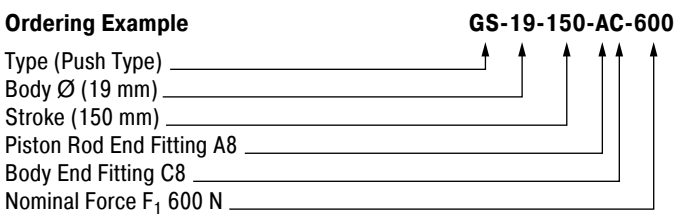

The end fittings are interchangeable.
For mounting accessories see page 200.

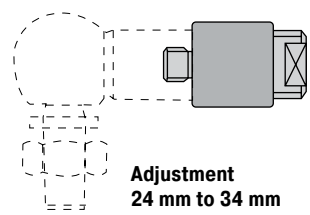

See page 207 for Length Adaptor.

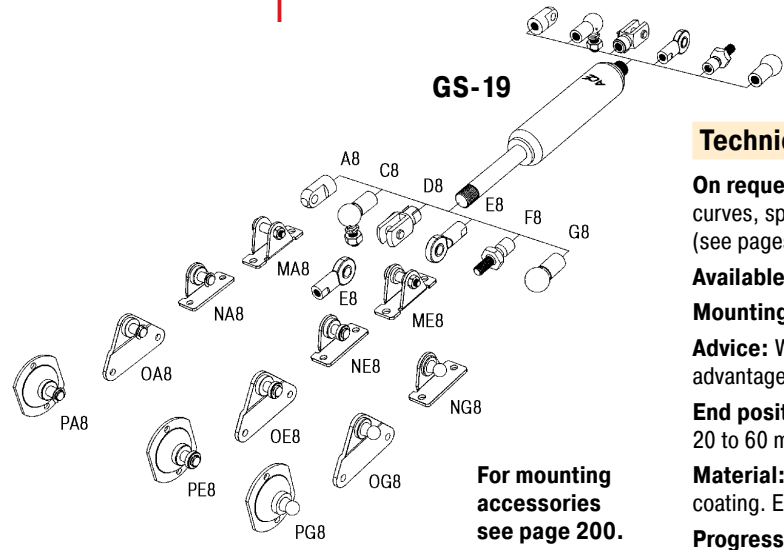
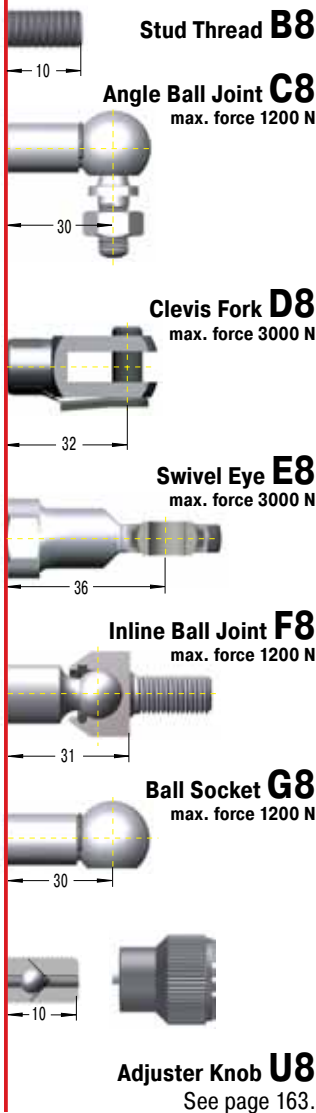
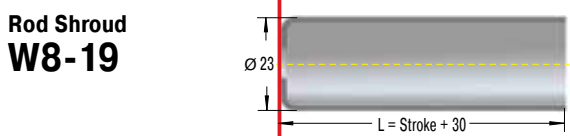

For mounting accessories see page 200.

Technical Data

- On request:** Without damping, standard length damping, special force curves, special lengths, alternative end fittings, wiper, stainless steel (see pages 179 to 186).
- Available force range F_1 at 20 °C:** 50 N to 700 N
- Mounting:** In any position
- Advice:** We recommend mounting with piston rod downwards to take advantage of the built-in end position damping.
- End position damping length:** Strong end position damping approx. 20 to 60 mm (depending on the stroke) and slow extension speed.
- Material:** Body: Black coated steel. Piston rod: With wear-resistant coating. End fittings: Zinc plated steel.
- Progression:** Approx. 36% to 42%, F_2 max. 995 N

Issue 6.2011 Specifications subject to change

End Fitting

Standard Dimensions

End Fitting

A8 Eye **A8**
max. force 3000 N

B8 Stud Thread **B8**

C8 Angle Ball Joint **C8**
max. force 1200 N

D8 Clevis Fork **D8**
max. force 3000 N

E8 Swivel Eye **E8**
max. force 3000 N

F8 Inline Ball Joint **F8**
max. force 1200 N

G8 Ball Socket **G8**
max. force 1200 N

U8 Adjuster Knob **U8**
See page 163.

W8-22 Rod Shroud

Adjustment
24 mm to 34 mm

See page 207 for Length Adaptor.

Dimensions		
Type	Stroke mm	L extended
GS-22-50	50	164
GS-22-100	100	264
GS-22-150	150	364
GS-22-200	200	464
GS-22-250	250	564
GS-22-300	300	664
GS-22-350	350	764
GS-22-400	400	864
GS-22-450	450	964
GS-22-500	500	1 064
GS-22-550	550	1 164
GS-22-600	600	1 264
GS-22-650	650	1 364
GS-22-700	700	1 464

Ordering Example
GS-22-150-AE-800
 Type (Push Type) _____
 Body Ø (23 mm) _____
 Stroke (150 mm) _____
 Piston Rod End Fitting A8 _____
 Body End Fitting E8 _____
 Nominal Force F₁ 800 N _____

**The end fittings are interchangeable.
For mounting accessories see page 200.**

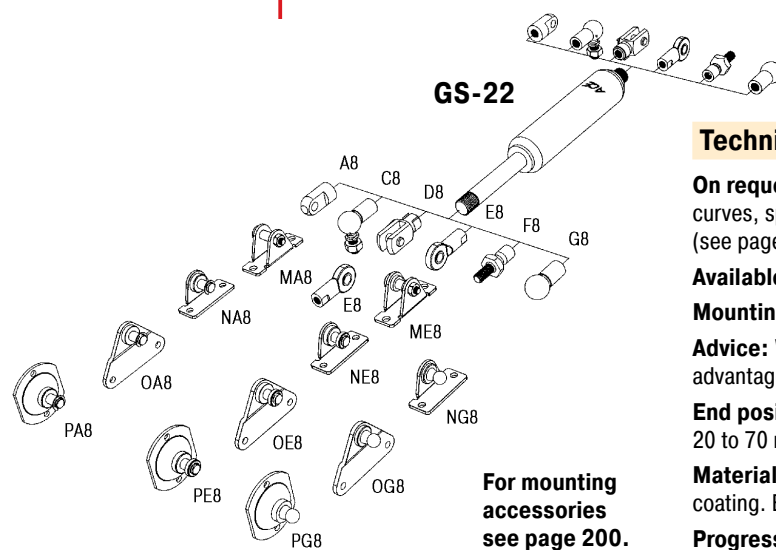

Technical Data

On request: Without damping, standard length damping, special force curves, special lengths, alternative end fittings, wiper, stainless steel (see pages 179 to 186).

Available force range F₁ at 20 °C: 80 N to 1300 N

Mounting: In any position

Advice: We recommend mounting with piston rod downwards to take advantage of the built-in end position damping.

End position damping length: Strong end position damping approx. 20 to 70 mm (depending on the stroke) and slow extension speed.

Material: Body: Black coated steel. Piston rod: With wear-resistant coating. End fittings: Zinc plated steel.

Progression: Approx. 39% to 50%, F₂ max. 1950 N

Issue 6.2011 Specifications subject to change

Extension Forces 150 N to 2500 N
(when Piston Rod Compressed up to 4875 N)

End Fitting

Standard Dimensions

End Fitting

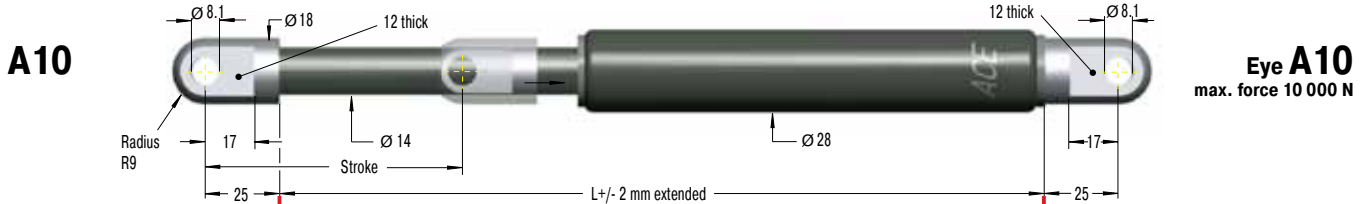

B10

C10

D10

E10

F10

Rod Shroud W10-28

Dimensions		
Type	Stroke mm	L extended
GS-28-100	100	262
GS-28-150	150	362
GS-28-200	200	462
GS-28-250	250	562
GS-28-300	300	662
GS-28-350	350	762
GS-28-400	400	862
GS-28-450	450	962
GS-28-500	500	1 062
GS-28-550	550	1 162
GS-28-600	600	1 262
GS-28-650	650	1 362
GS-28-700	700	1 462
GS-28-750	750	1 562

Ordering Example

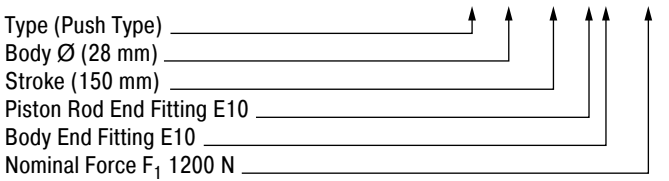

The end fittings are interchangeable.
For mounting accessories see page 200.

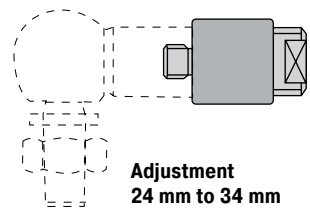
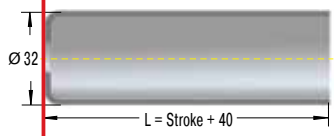

See page 207 for Length Adaptor.

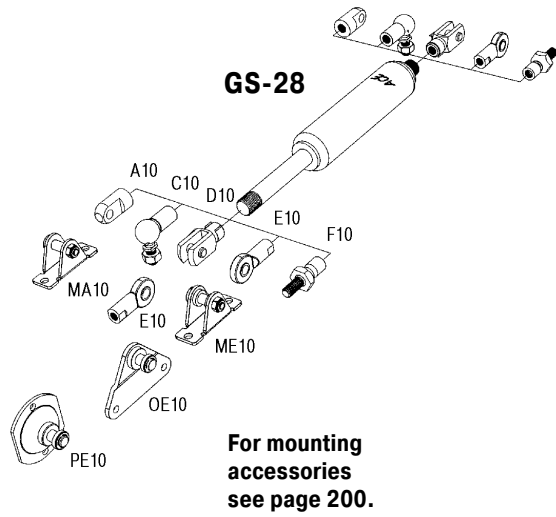

For mounting accessories see page 200.

Technical Data

On request: Without damping, standard length damping, special force curves, special lengths, alternative end fittings, wiper, stainless steel (see pages 179 to 186).

Available force range F_1 at 20 °C: 150 N to 2500 N

Mounting: In any position

Advice: We recommend mounting with piston rod downwards to take advantage of the built-in end position damping.

End position damping length: Strong end position damping approx. 30 to 70 mm (depending on the stroke) and slow extension speed.

Material: Body: Black coated steel. Piston rod: With wear-resistant coating. End fittings: Zinc plated steel.

Progression: Approx. 60% to 95%, F_2 max. 4875 N

End Fitting

Standard Dimensions

End Fitting

A14

Ø14.1, Ø25, 14 thick, Radius R12.5, 21, Stroke, Ø20, Ø40, 40, L +/- 2 mm extended

Dimensions

Type	Stroke mm	L extended
GS-40-100	100	317
GS-40-150	150	417
GS-40-200	200	517
GS-40-300	300	717
GS-40-400	400	917
GS-40-500	500	1 117
GS-40-600	600	1 317
GS-40-800	800	1 717
GS-40-1000	1 000	2 117

Ordering Example

GS-40-150-DD-3500

Type (Push Type) _____
 Body Ø (40 mm) _____
 Stroke (150 mm) _____
 Piston Rod End Fitting D14 _____
 Body End Fitting D14 _____
 Nominal Force F₁ 3500 N _____

The end fittings are interchangeable.
For mounting accessories see page 201.

B14

M14x1.5, 15

C14

Ø30, Ø22, 20, 25, 45, M14x1.5, 36°

D14

Ø14, 27, 14, 16, 27, 56

E14

30°, Ø14, 13, Ø20, 19, 18, 57, 30

F14

M14x1.5, 30°, AF24, AF22, 40, 56, 18

Rod Shroud W14-40

Ø45, L = Stroke + 40

Eye A14
max. force 10 000 N

Stud Thread B14

Angle Ball Joint C14
max. force 3200 N

Clevis Fork D14
max. force 10 000 N

Swivel Eye E14
max. force 10 000 N

Inline Ball Joint F14
max. force 3200 N

Adjuster Knob U14
See page 163.

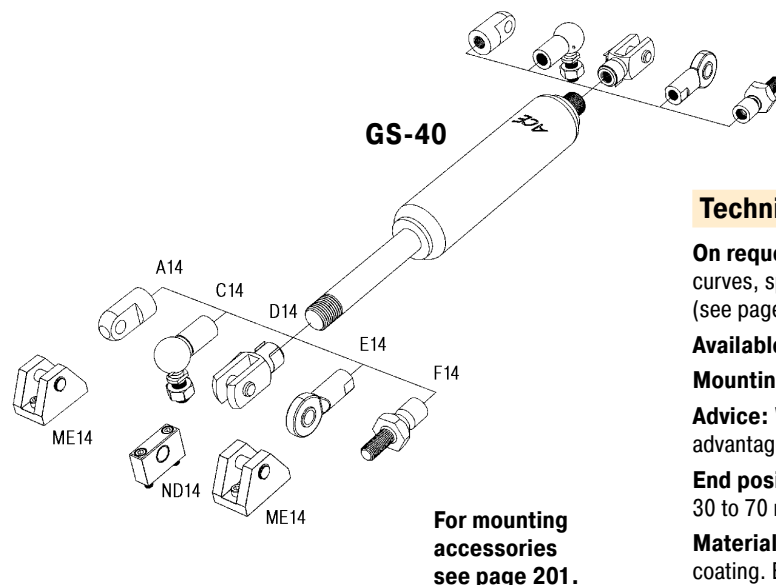

Technical Data

On request: Without damping, standard length damping, special force curves, special lengths, alternative end fittings, wiper, stainless steel (see pages 179 to 186).

Available force range F₁ at 20 °C: 500 N to 5000 N

Mounting: In any position

Advice: We recommend mounting with piston rod downwards to take advantage of the built-in end position damping.

End position damping length: Strong end position damping approx. 30 to 70 mm (depending on the stroke) and slow extension speed.

Material: Body: Black coated steel. Piston rod: With wear-resistant coating. End fittings: Zinc plated steel.

Progression: Approx. 47 % to 53 %, F₂ max. 7650 N

End Fitting

Standard Dimensions

End Fitting

B24

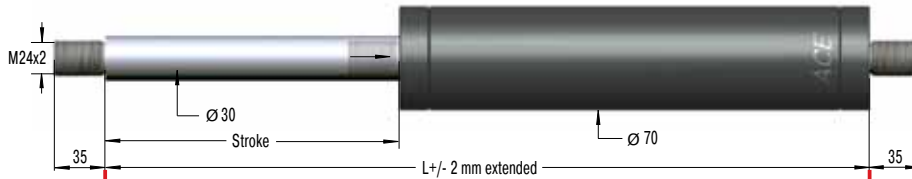

Stud Thread **B24**

D24

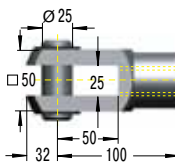

Clevis Fork **D24**
max. force 50 000 N

E24

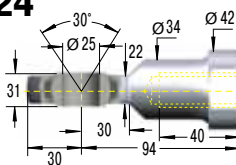

Swivel Eye **E24**
max. force 50 000 N

Dimensions

Type	Stroke mm	L extended
GS-70-100	100	320
GS-70-200	200	520
GS-70-300	300	720
GS-70-400	400	920
GS-70-500	500	1 120
GS-70-600	600	1 320
GS-70-700	700	1 520
GS-70-800	800	1 720

Ordering Example

GS-70-200-EE-8000

Type (Push Type) _____
 Body Ø (70 mm) _____
 Stroke (200 mm) _____
 Piston Rod End Fitting E24 _____
 Body End Fitting E24 _____
 Nominal Force F_1 8000 N _____

The end fittings are interchangeable.
 For mounting accessories see page 201.
 Standard gas spring with valve.

Rod Shroud
W24-70

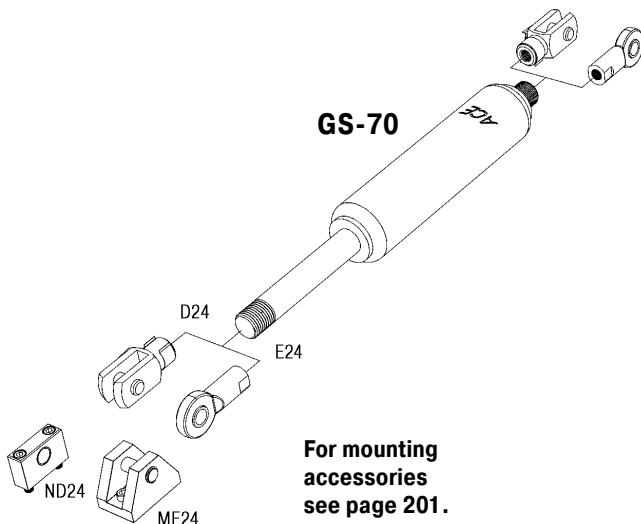
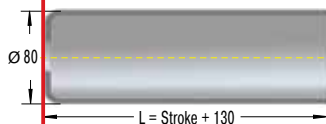

For mounting
accessories
see page 201.

Technical Data

On request: Without damping, extended length damping, special force curves, special lengths, alternative end fittings, wiper, stainless steel.

Available force range F_1 at 20 °C: 2000 N to 13 000 N

Mounting: In any position

Advice: We recommend mounting with piston rod downwards to take advantage of the built-in end position damping.

End position damping length: Approx. 10 mm

Material: Body: Black coated steel or zinc plated steel. Piston rod: Hard chrome plated. End fittings: Zinc plated steel.

Progression: Approx. 25 %, F_2 max. 16 250 N